

专案名称:	Axpert VM III-5000/VM III-3000				
专案编号:	S1711171	修订版次:	00	PAGE	1 / 3



旭隼  日月元

# 维修手册

Prepared by: Clay Lin      Date: \_\_\_\_\_

Checked by: \_\_\_\_\_      Date: \_\_\_\_\_

Approved by: \_\_\_\_\_      Date: \_\_\_\_\_



维修手册

专案名称: Axpert VM III-5000/VM III-3000

专案编号: S1711171

修订版次:

00

PAGE

**Axpert VM III-5000/ VM III-3000  
Service manual**



**Table of contents**

<b>1. GENERAL INFORMATION .....</b>	<b>5</b>
1.1 GETTING START .....	5
1.2 BASIC TOPOLOGY INTRODUCTION .....	5
1.3 INVERTER FAMILY .....	5
1.4 OVERVIEW THE INVERTER .....	6
<b>2. TROUBLESHOOTING .....</b>	<b>6</b>
2.1 HOW TO DO .....	6
2.2 FAULT CONDITION .....	6
2.3 TEST STEP.....	7
<b>3. CHECKING AND MEASURING GUIDE.....</b>	<b>8</b>
3.1 CHECK THE BATTERY SIDE COMPONENTS ON MAIN BOARD.....	8
3.2 CHECK THE BUS SIDE COMPONENTS ON MAIN BOARD.....	15
3.3 CHECK THE BUCK CIRCUIT ON MAIN BOARD.....	16
3.4 CHECK THE INV FULL BRIDGE ON MAIN BOARD .....	18
3.5 CHECK BATT AND MAIN POWER SPS ON MAIN BOARD .....	21
3.6 CHECK AC SPS ON MPPT BOARD.....	25
3.7 CHECK THE BUS SOFT START CIRCUIT ON MPPT BOARD (TX1: ESPECIALLY FOR 09 FAULT) .....	26
3.8 CHECK THE BOOST ON MPPT BOARD.....	28
<b>4. DISASSEMBLING GUIDE.....</b>	<b>30</b>
TOTAL WIRING DIAGRAM:.....	33

## 1. General information

### 1.1 Getting start

This manual is used as a checking and repairing guide for Axpert VMIII-5200 and VMIII-3200. Before read this manual, it's better to have some electrical or electronic background knowledge. With this guide, you can fix the inverter by yourself firstly.

There are five main parts of this guide:

**General information:** This part is the basic information of the inverter; you can start to know the inverter from this chapter.

**Troubleshooting:** This part will tell you how to do when you face a problem.

**Checking and measuring guide:** This part will teach you how to check or repair the inverter by measuring the critical components.

**Assembling guide:** This part teaches you how to take the board outside and fix the new one.

**Cables connection guide:** This part will present the signal cables connection of the inverters.

### 1.2 Basic topology introduction

The topology of the inverter shows as below:

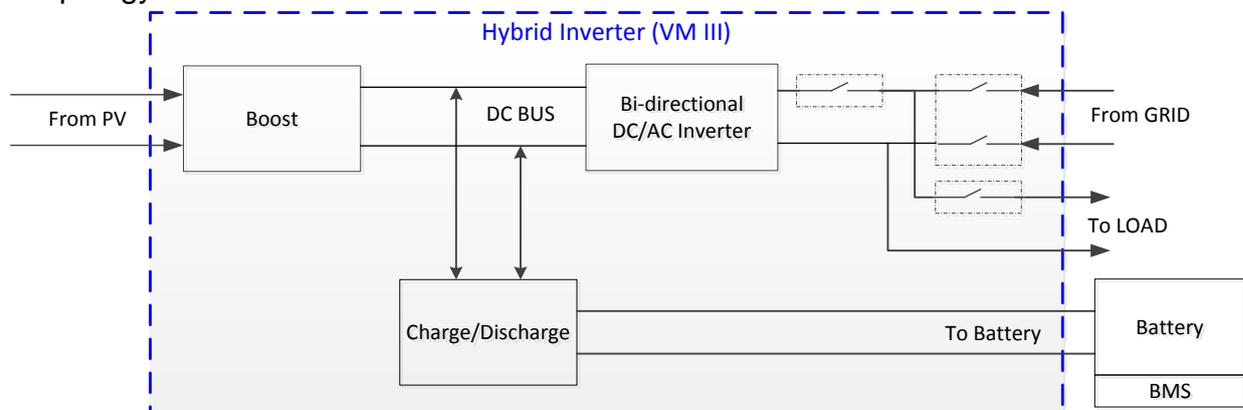

Compare with UPS or normal inverter, INVERTER combines a solar charger inside. Solar charger can be a supplement for battery when there is not grid. And with the solar charger, the inverter can have more working modes than UPS. For detail information please refer to our user manual.

### 1.3 Inverter family

This service manual includes different models of the inverter, the table as below contains some important parameters with different models.

These models names are only neutral names; please match the real model name of your inverter to the model name in the table by comparing the typical characteristics.

Model name	Power rating	Charger type	Charger number
Axpert VMIII-5000	5.2KVA	MPPT	1
Axpert VMIII-3000	3.2KVA	MPPT	1

## 1.4 Overview the inverter Axpert VMIII



## 1 Troubleshooting

### 1.5 How to do

When the inverter was faulty, normally there are two main symptoms:

- No display at all;
- Fault code or warning code on the LCD;

When the fault occurred, please help to record the fault information and follow “How to check” of part 2.2 to check the inverter, then feedback the checking result to the service center. It will be very helpful for solving the problem as soon as possible.

### 1.6 Fault condition

#### **Note:**

**When open the top cover, please have a look first, are there any obviously damaged parts?**

**When take the main board out, please have a look around, are there any obviously damaged parts?**

专案名称: Axpert VM III-5000/VM III-3000

专案编号: S1711171      修订版次: 00      PAGE

**2.2.1. Not working at all/ No display**

Description	The inverter couldn't startup completely.
Possible reason	1. SPS module damaged.
How to check	1. Firstly, please measure the resistor between BAT+ and BAT-. If it is not shorted, only connect the inverter with battery, and press "ON" button, could the inverter startup? If not, please check the fan. 2. If the LCD couldn't light up and fan doesn't work, please disconnect all the wires and open the top cover, and then take the main board outside by following part 4. 3. Check the main board by following "3.5 and 3.6"
How to solve	Repair the main or replace it directly.

**2.2.2. 09 fault**

Description	Bus soft start fails.
Possible reason	DC-DC module was damaged or BUS soft start module was damaged.
How to check	1. Check the main board by following "3.6; 3.7"; 2. Check the main board by following "3.1; 3.2; 3.3; 3.4".
How to solve	Repair the main board or replace it directly.

**2.2.3.  Warning**

Description	Battery couldn't be detected.
Possible reason	Wire connection or fuse was burnt.
How to check	1. Check the wire connection, the priority of the battery cable; 2. Check the main board by following "3.1".
How to solve	Repair the main board or replace it directly.

**1.7 Test step**

After replacing all defected components, testing steps can be used to confirm the repair result and the reliability of the Inverter.

Set up the testing system as below:

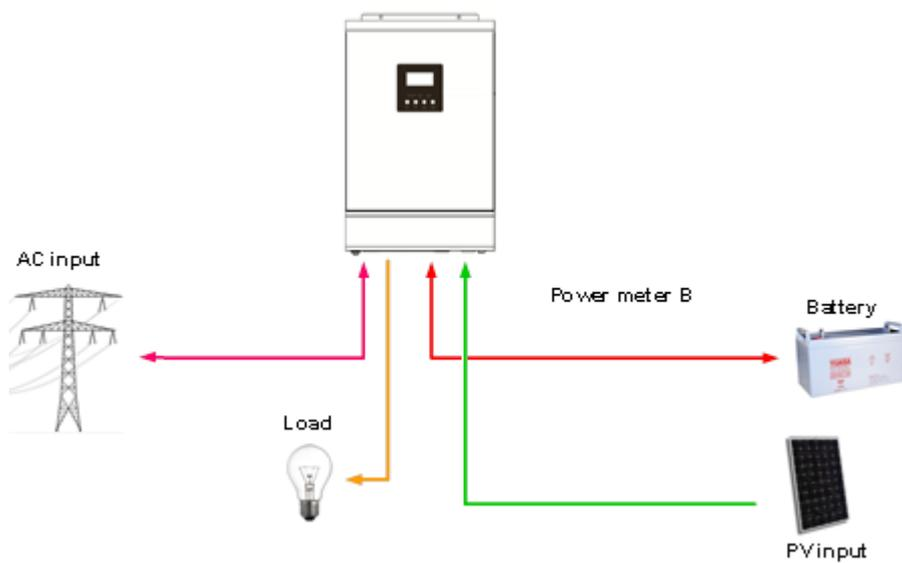

## 2. Checking and measuring guide

2.1 Check the battery side components on MAIN board

### Fuse and capacitors

For VMIII-3000 FUCE 150A

For VMIII-5000 FUCE 150A



Parts	Attribute	Reference values	Failure status
F5	Resistor	0.1 ohm	Open

For VMIII-3000 C9/C11/C12/C196/C152: (4200uF 35V)

For VMIII-5000 C9/C18/C196: (6800uF 63V)



If the capacitors explode as below, they need to be replaced.



**Power devices**

DC/DC MOSFET: Q13/Q18/Q23/Q35 & Q25/Q26/Q39/Q40



For VMIII-3000 ALL of the MOSFET are (CSD19505KCS 201A 80V TO-220)

专案名称: Axpert VM III-5000/VM III-3000

专案编号: S1711171

修订版次:

00

PAGE

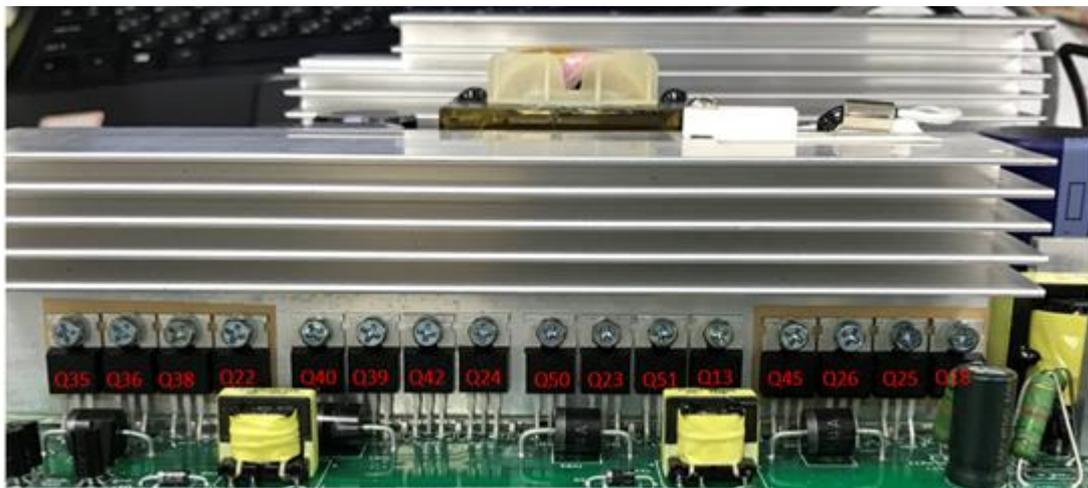

For VMIII-5000 ALL of the MOSFET are (MOSFET TOSHIBA/TK100E08N1 214A 80V N BULK TO-220)

Parts	Attribute	Reference values	Failure status
CSD19505KCS (VMIII-3200)	Resistor	GS: 11.75k	Short or explosion
TK100E08N1 (VMIII-5200)		GD: 115.8k DS: OL	
	Diode	SD: 0.463V DS: OL	

**Note1:** When you use the multimeter to measure the resistor of the transistor, because of the capacitor in the circuit, it will cause the changing of the values when you measure the DS and GD. So we recommend you measure the diode forward voltage of SD, and the resistor of GS. These two values can reflect the situation of the transistor more correctly.

**Note2:** If one or more of them were damaged, please replace all of them.

### 3.1.1. Drivers (This part is only used for repair checking)

**Note:** Drivers usually need to be checked when users want to repair the boards. Because when power devices were damaged, the high voltage will rush to driver circuit through the gates of power devices.

The reference of the resistors list as below:

R52/R62/R81/R87/R92/R93/R115/R119 All of the resistors are (22R 1206)

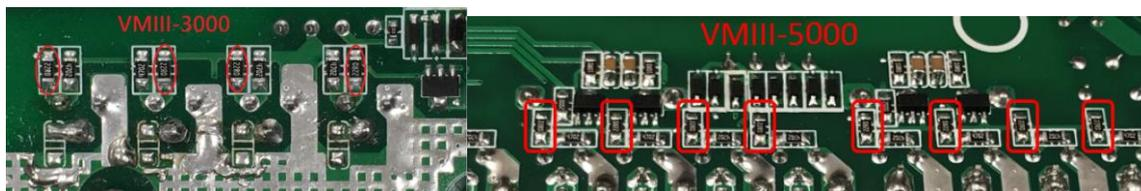

维修手册

专案名称: Axpert VM III-5000/VM III-3000

专案编号: S1711171

修订版次:

00

PAGE

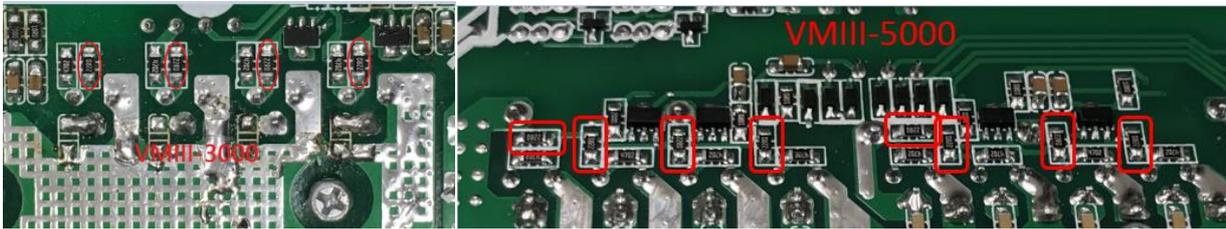

Use multimeter to measure each resistor, find the burnt resistors and replace them; don't need to replace them all.

Parts	Attribute	Reference values	Failure status
All: 22ohm	Resistor	22 ohm	Open or other values

If the resistors need to be replaced, please also check the driver transistors and control IC.



The Q46 and Q48 are (2SC2655 2A 50V NPN TAP TO-92)

The Q47 and Q49 are (2SA1020L-Y-T9N-B 2A 50V PNP TAP TO-92NL)



The Q41 and Q43 are (2SC2655 2A 50V NPN TAP TO-92)

The Q15 and Q16 are (2SA1020L-Y-T9N-B 2A 50V PNP TAP TO-92NL)

Parts	Attribute	Reference values	Failure status
Q46/Q48	Resistor	BE: 430k BC: 430k	Short or explosion

维修手册

专案名称: Axpert VM III-5000/VM III-3000

专案编号: S1711171

修订版次:

00

PAGE

		EC: 16k	
	Diode	BE: 0.65V BC: 0.65V CE: 0.28V	
Q41/Q43	Resistor	BE: 430k BC: 425k EC: 104k	Short or explosion
	Diode	BE: 0.65V BC: 0.65V CE: 0.28V	
Q47/Q49	Resistor	BE: 430k BC: 430k EC: 8k	Short or explosion
	Diode	BE: 0.65V BC: 1.75V CE: 0.20V	
Q15/Q16	Resistor	BE: 430k BC: 430k CE: 8k	Short or explosion
	Diode	BE: 0.65V BC: 1.5V CE: 0.28V	

维修手册

专案名称: Axpert VM III-5000/VM III-3000

专案编号: S1711171

修订版次:

00

PAGE

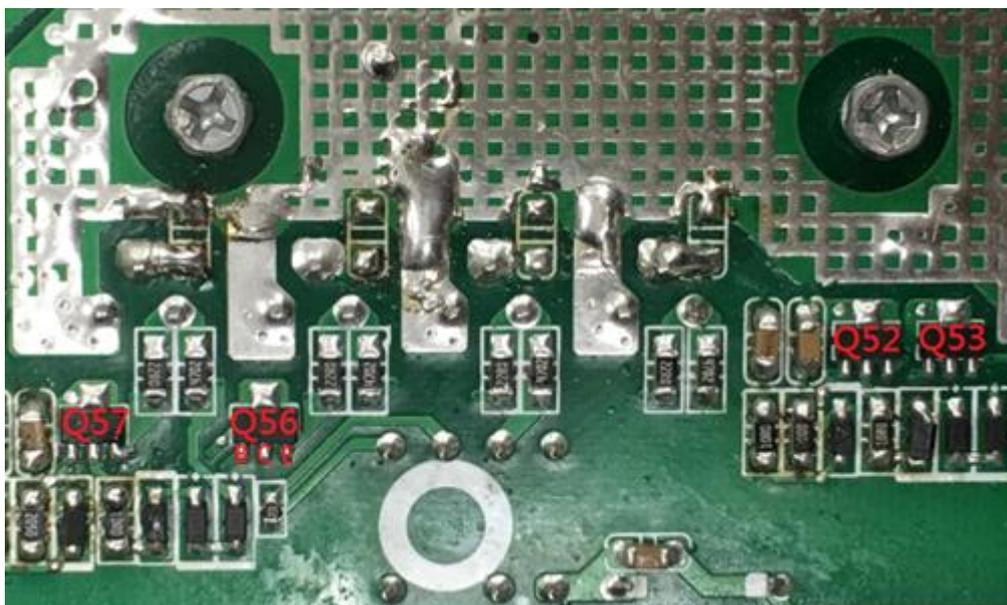

The Q52 and Q56 are (2SD1624 2A 50V NPN SOT-89)

The Q53 and Q57 are (2SA1020 3A 50V PNP SOT-89)

Parts	Attribute	Reference values	Failure status
Q52/Q56	Resistor	BE: 12k BC: 280k CE: OL	Short or explosion
	Diode	BE: 0.64V BC: 0.64V CE: OL	
Q53/Q57	Resistor	BE: 12k BC: OL CE: 280k	Short or explosion
	Diode	BE: 0.64V BC: OL CE: 1.09V	

维修手册

专案名称: Axpert VM III-5000/VM III-3000

专案编号: S1711171

修订版次:

00

PAGE

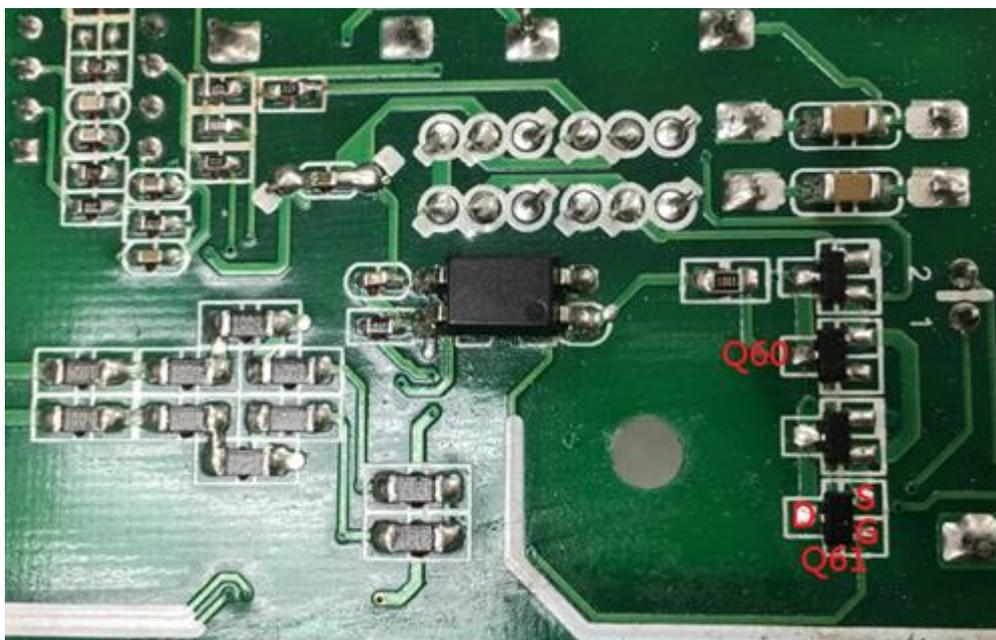

The Q60 and Q61 the MOSFET are (UT3404G 5.8A 30V NPN SOT-23 SMD)

Parts	Attribute	Reference values	Failure status
Q60/Q61	Resistor	GS: 5.637k GD: 107k SD: 98k	Short or explosion
	Diode	SD: 0.28V DS: 1.14V	

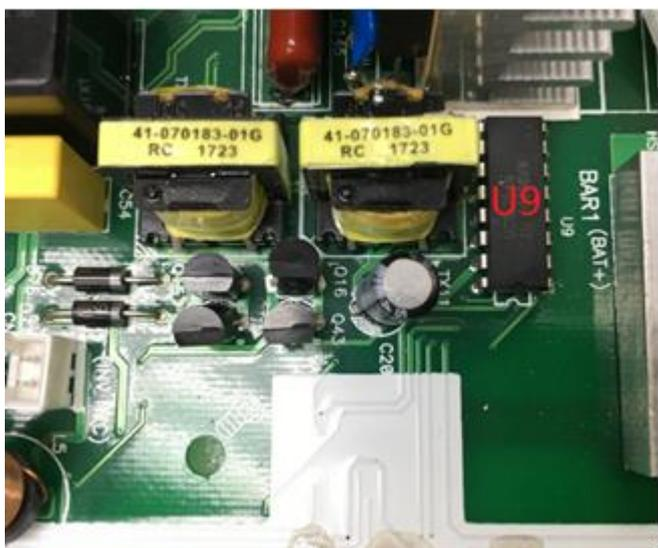

专案名称: Axpert VM III-5000/VM III-3000

专案编号: S1711171      修订版次: 00      PAGE

The U9 is (IC PWM CNTL TI/UC3525AN DIP-16)

Parts	Attribute	Reference values	Failure status
U9	Resistor	PIN13 TO PIN12: 8.8k PIN11 TO PIN12: 432k PIN14 TO PIN12: 432k	Short or explosion

2.2 Check the bus side components on MAIN board

**Power devices**

DC/DC IGBT: Q27/Q28/Q29/Q30



For VMIII-5000 ALL of the IGBTs are (IGBT ST/STGW60H65DFB 60A 650V N BULK TO-247)

For VMIII-3000 ALL of the IGBTs are (STGW45HF60WDA 45A 600V NPN BULK TO-247)

Parts (VMIII-3200)	Attribute	Reference values	Failure status
Q27/Q28/Q29/Q30	Resistor	GE: 22 ohm GC: 184k EC: 184K	Short or explosion
	Diode	EC: 0.37V CE: OL	
Parts (VMIII-5200)	Attribute	Reference values	Failure status
Q27/Q28/Q29/Q30	Resistor	GE: 22 ohm GC: 205k EC: 205K	Short or explosion
	Diode	EC: 0.39V CE: OL	

**Note1:** When you use the multimeter to measure the resistor of the transistor, because of the capacitor in the circuit, it will cause the changing of the values when you measure the CE and GE. So we recommend you measure the diode forward voltage of EC, and the resistor of GE. These two values can reflect the situation of the transistor more correctly.

**Note2:** If one or more of them were damaged, please replace all of them.

专案名称: Axpert VM III-5000/VM III-3000

专案编号: S1711171

修订版次:

00

PAGE

**Drivers (This part is only used for repair checking)**

Meanwhile, we also need to check the driver tubes of these power tubes.

R91/R102/R96/R101: (22R 1206)

R90/R99/R94/R97: (0R 1206)

D32/D35/D33/D34: (1N4148W 0.15A 75V SMD)

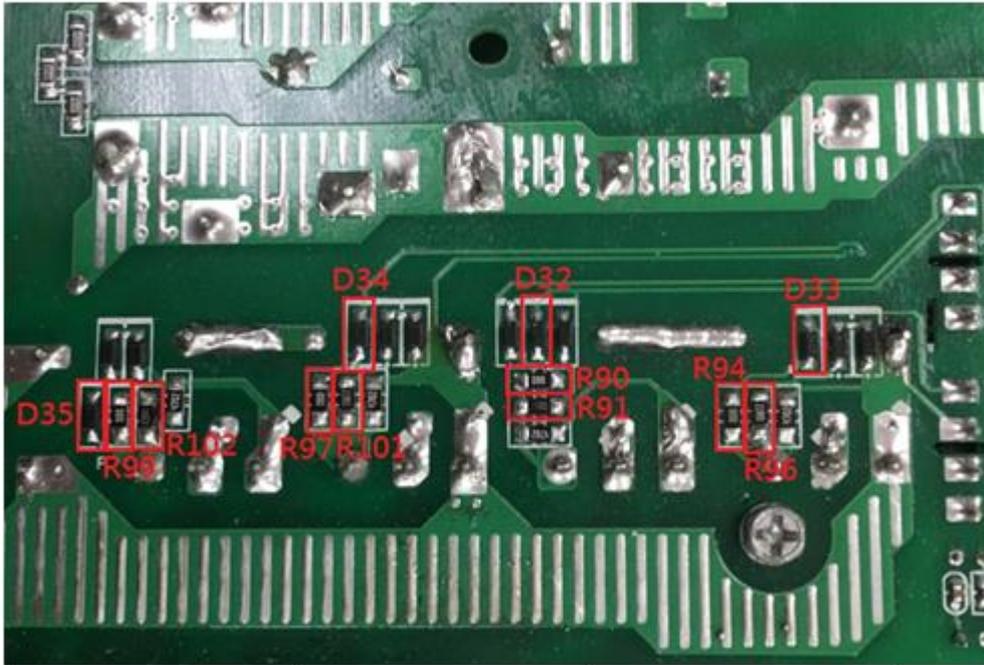

Parts	Attribute	Reference values	Failure status
R91/R102/R96/R101	Resistor	22 ohm	Open or other values
R90/R99/R94/R97	Resistor	0 ohm	
D32/D35/D33/D34 <sup>1</sup>	Resistor	+ to -: 270k - to +: OL	Short or explosion
	Diode	+ to -: 0.6V - to +: OL	

**Note1:** When test the diode; please remove the R90/R99/R94/R97 from the board, or the test result is not right.

2.3 Check the buck circuit on MAIN board

**Power devices**

BUCK MOSFET and Diode: Q31/D13

专案名称: Axpert VM III-5000/VM III-3000

专案编号: S1711171

修订版次:

00

PAGE



For VMIII-5000 the IGBTs Q31 is (IGBT ST/STGW60H65DFB 60A 650V N BULK TO-247)

For VMIII-3000 the IGBTs Q31 is (STGW45HF60WDA 45A 600V NPN BULK TO-247)

The D13 is (RHRP1560 15A 600V UFST RAD BULK)

Parts	Attribute	Reference values	Failure status
Q31	Resistor	GE: 22.8k GC: 49.5k CE: OL	Short or explosion
	Diode	CE: OL EC: 0.393V	
D13	Resistor	+ to -: 195k - to +: OL/OL	
	Diode	+ to -: 0.39V - to +: OL	

**Drivers (This part is only used for repair checking)**

专案名称: Axpert VM III-5000/VM III-3000

专案编号: S1711171

修订版次:

00

PAGE

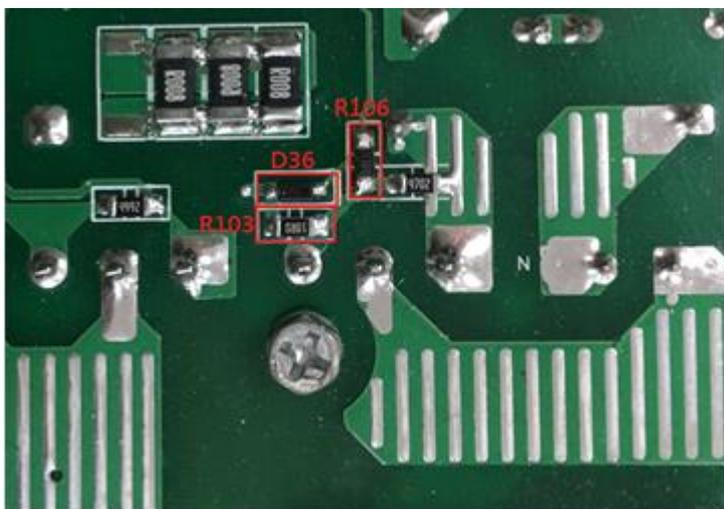

The R103 are (10R 1206)

The R106 are (47R 1206)

The D36 are (1N4148W 0.15A 75V SMD)

Parts	Attribute	Reference values	Failure status
R106	Resistor	47 ohm	Open or other values
R103	Resistor	10 ohm	
D36 <sup>1</sup>	Resistor	+ to -: 240k - to +: OL	Short or explosion
	Diode	+ to -: 0.6V - to +: OL	

**Note1:** When test the diode; please remove the R103 from the board, otherwise the test result is not right.

2.4 Check the INV full bridge on MAIN board

**Power devices**

INV IGBT: QA1/QC1/QB2/QD2

专案名称: Axpert VM III-5000/VM III-3000

专案编号: S1711171

修订版次:

00

PAGE

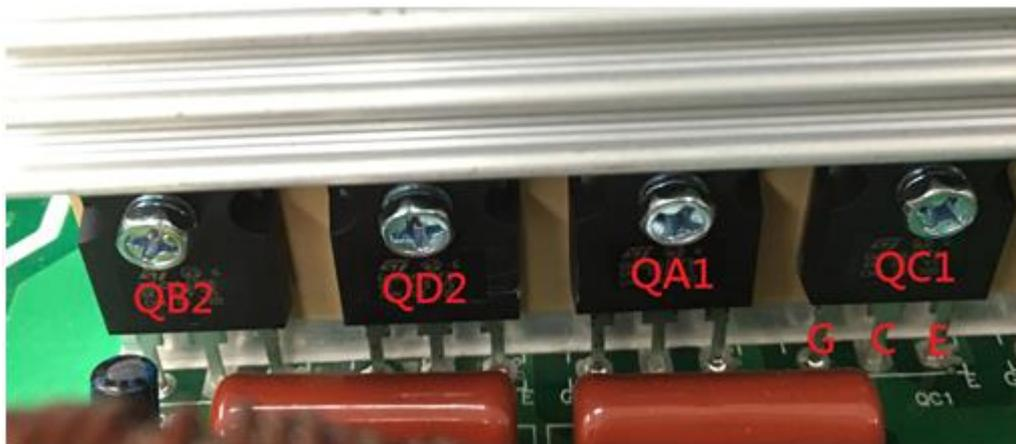

All of the IGBT are (STGW60H65DFB 60A 650V N BULK TO-247)

Parts	Attribute	Reference values	Failure status
QA1/QC1/QB2/QD2	Resistor	GE: 23k GC: 235k CE: 700k	Short or explosion
	Diode	EC: 0.4V CE: OL	

Note1: If one or more of them were damaged, please replace all of them.

### Drivers

R48/R144/R140/R137: (39R 1206)

R139/R145/R150/R152: (10R 1206)

D5/D6/D12/D16: (1N4148W 0.15A 75V SMD)

专案名称: Axpert VM III-5000/VM III-3000

专案编号: S1711171

修订版次:

00

PAGE

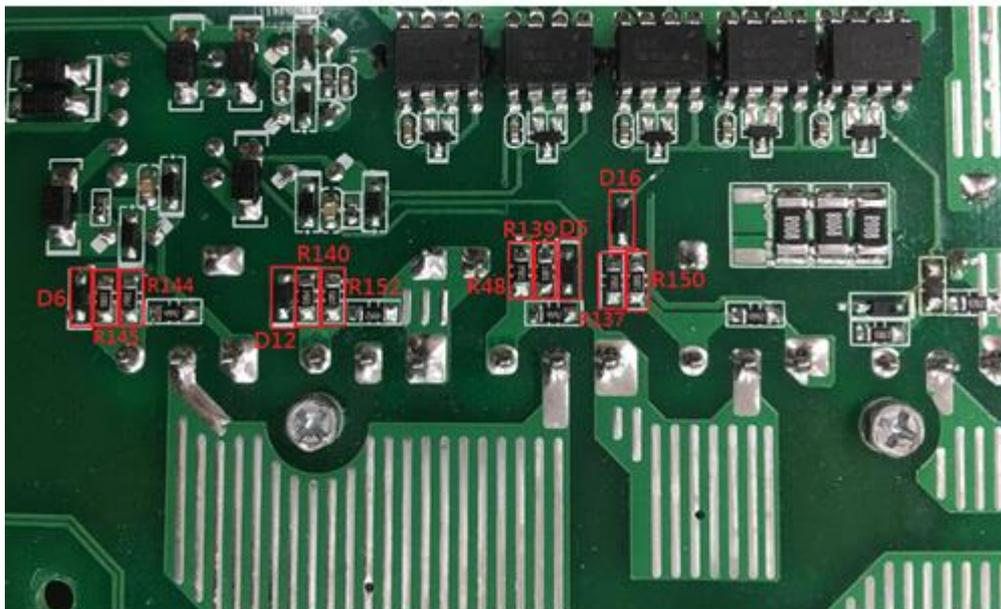

Parts	Attribute	Reference values	Failure status
R48/R144/R140/R137	Resistor	39 ohm	Open or other values
R139/R145/R150/R152	Resistor	10 ohm	Open or other values
D5/D6/D12/D16 <sup>1</sup>	Resistor	+ to -: 270k - to +: OL	Short or explosion
	Diode	+ to -: 0.6V - to +: OL	

**Note1:** When test the diode; please remove the R139/R145/R150/R152 from the board, ortherwise the test result is not right

Optocoupler: U1/U2/U3/U4/U12

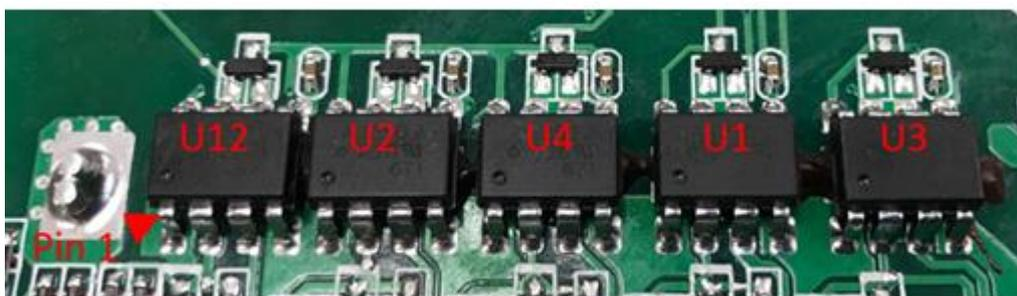

ALL of the optocoupler are (AVAGO/T350-560E DIP-8 8/300 MIL SMD)

专案名称: Axpert VM III-5000/VM III-3000

专案编号: S1711171

修订版次:

00

PAGE

Parts	Attribute	Reference values	Failure status
U2/U4/U12	Resistor	PIN8 TO PIN5: 57k PIN7 TO PIN5: 145k	Short or explosion
U1/U3	Resistor	PIN8 TO PIN5: 355k PIN7 TO PIN5: 410k	

## 2.5 Check BATT and Main Power SPS on MAIN board

### BATT Power SPS

For VMIII-5000 the F1 are (FUSE 3A 125V)

For VMIII-3000 the F1 are (FUSE 5A 125V)

For VMIII-5000 the NTC2 are (THERMISTOR NTC 5OHM 5A SCK13055LSY)

For VMIII-3000 the NTC2 are (NTC 5ohm 5A)

For VMIII-5000 the MOSFET Q69 are (MOSFET IR/IRF740 10A 400V N BULK TO-220)

For VMIII-3000 the MOSFET Q69 are (IRF640NPBF 18A 200V N BULK TO-220)

For VMIII-5000 the R246 are NC

For VMIII-3000 the R246 are (RES 3W 0.15ohm)

The TX2 are (TX 2:5:45:3 FER EC28)

The R245 are (RES 3W 0.15ohm)

The D61 are (MUR4100ERLG 4A 1000V UFST)

The D60 are (RHRP860 8A 600V SFST)

The U14 are (IC UC3845BNG DIP-8)

The Q6 are (PMBT2907A 0.6A 60V SMD)

The TX3 are (TX 16:16:16 FER EE16)

The D65 are (RS1J 1A 600V SMD)

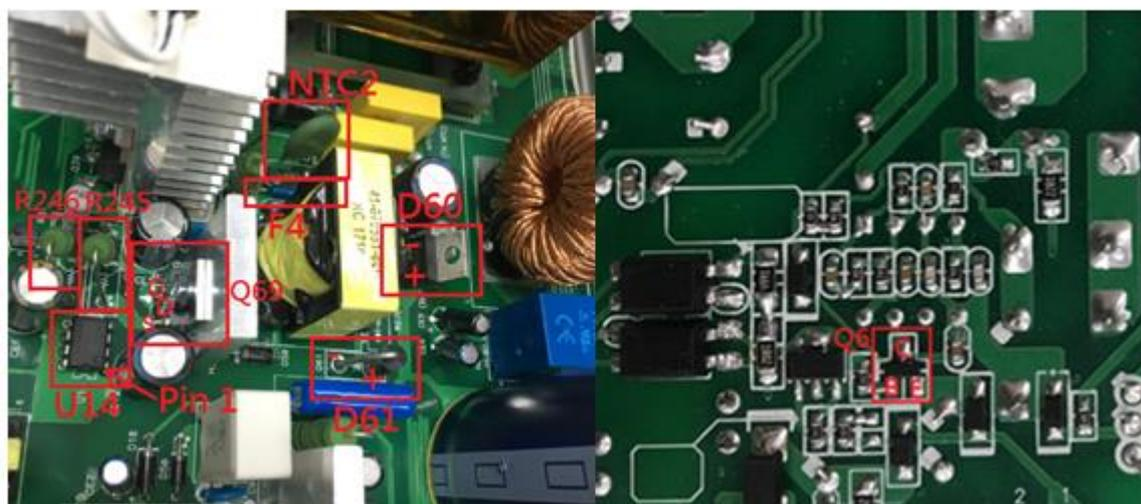

维修手册

专案名称: Axpert VM III-5000/VM III-3000

专案编号: S1711171

修订版次:

00

PAGE

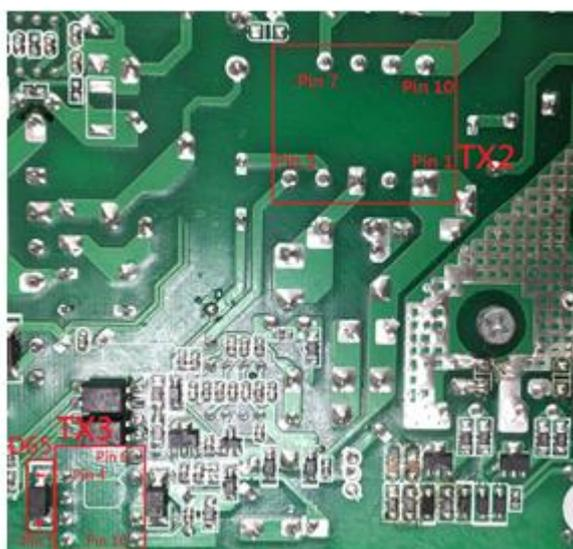

Parts	Attribute	Reference values	Failure status
F4	Resistor	0 ohm	Open or explosion
NTC2	Resistor	5 ohm	Open or explosion
D61	Diode	+ to -: 0.468V - to +: OL	Short or explosion
D60	Diode	+ to -: 0.435V - to +:OL	Short or explosion
R245	Resistor	0.65ohm	Open or other values
VMIII-3000 R246 VMIII-5000 R245	Resistor	0.65ohm NC	Open or mother values
Q69 <sup>1</sup>	Resistor	GS: 45.51k GD: 57k(VMIII-5000) GD: 44.6k(VMIII-3000) SD: 528K(VMIII-5000) SD: 115K(VMIII-3000)	Short or explosion
	Diode	SD: 0.463V GS: OL	
U14	Resistor	PIN7 TO PIN5: 77.5K PIN6 TO PIN5: 45.48K	Short or other values
Q6	Resistor	EB: 512k	Short or other values

维修手册

专案名称: Axpert VM III-5000/VM III-3000

专案编号: S1711171

修订版次:

00

PAGE

		CB: 456k	
	Diode	CB: 0.688V EB: 0.691V	
VMIII-5K TX2	Resistor	PIN7 to PIN9: 0.57 ohm	Short or other values
VMIII-3K TX2	Resistor	PIN7 to PIN9: 0.4ohm	Short or other values
TX3	Resistor	PIN9 to PIN10: 0.3ohm	Short or other values
D65 <sup>2</sup>	Diode	+ to -: 0.52V - to +: OL	Short or explosion

**Note1:** When test the Q69; please remove the R245 from the board, otherwise the test result is not right

**Note2:** When test the D69; please remove the D65 from the board, otherwise the test result is not right

**Main Power SPS**

The MOSFET Q9 are (IXFP7N100P 7A 1000V N BULK TO-220)

The Q8 are (2SC5353BL 3A 750V TO-126C)

The U8 are (IC PWM UC3845BNG DIP-8)

The R203 are (RES 5W 0.5ohm)

The R204 are (RES 1/4W 10ohm 1206)

The D53 are (1N4148W 0.15A 75V SMD)

The R67 are (RES 1/4W 10ohm 1206)

The D3 are (MUR460RLG 4A 600V UFST)

The D49 and D57 are (HER303 3A 200V UFST)

The U7 are (IC L7912CV 3P TO-220)

The U10 are (IC MC78M05CDTRKG DPAK-3)

The TX4 are (TX 8:21:2:4:8:21:7 FER EC28)

维修手册

专案名称: Axpert VM III-5000/VM III-3000

专案编号: S1711171

修订版次:

00

PAGE

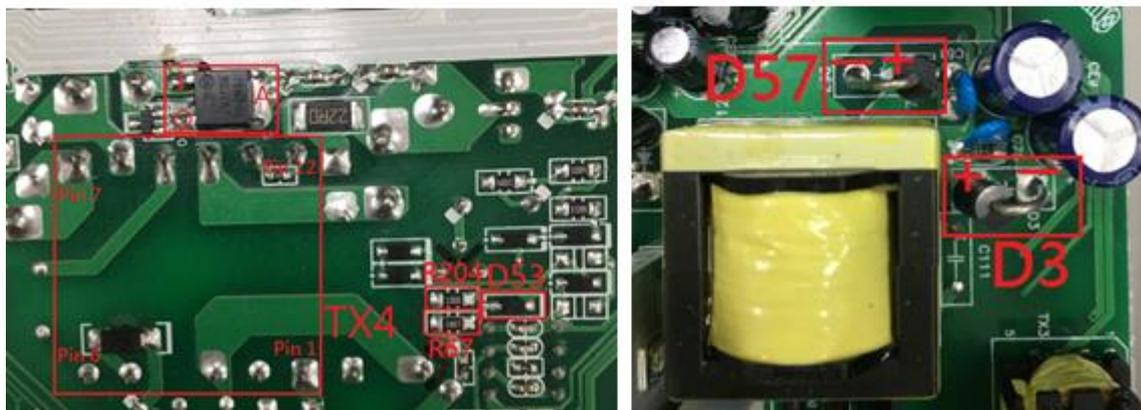
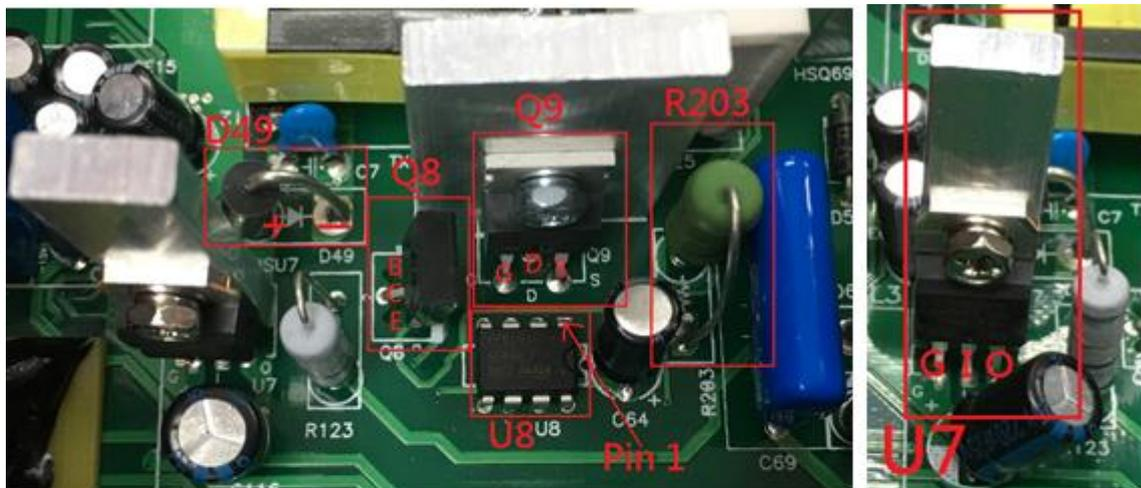

Parts	Attribute	Reference values	Failure status
Q9	Resistor	GS: 45k SD: 300K	Short or explosion
	Diode	SD: 0.52V SG: 0.73V	
Q8	Resistor	BC: 356k BE: 413k	Short or explosion
	Diode	BC: 0.59V BE: 0.61V	
U8	Diode	PIN5 TO PIN7: 0.48V PIN5 TO PIN6: 0.64V	Short or other values
R203	Resistor	0.5 ohm	Open or other values
R204	Resistor	10 ohm	Open or other

维修手册

专案名称: Axpert VM III-5000/VM III-3000

专案编号: S1711171      修订版次: 00      PAGE

			values
D53 <sup>1</sup>	Diode	+ to -: 0.52V - to +: OL	Short or explosion
R67	Resistor	10 ohm	Open or other values
D3	Diode	+ to -: 0.4V - to +: 0.7V	Short or explosion
D49/D57	Diode	+ to -: 0.45V - to +: OL	Short or explosion
U7	Diode	PINI to PINO: 0.56V PINO to PING: 0.44V PINI to PING: 0.45V	Short or explosion
U10	Diode	PINA TO PINI: 0.45V PINA TO PINO: 0.5V	Short or explosion
TX4	Resistor	PIN1 TO PIN3: 0.4 ohm	Short or other values

**Note1:** When test the D53; please remove the R67 from the board, otherwise the test result is not right

2.6 Check AC SPS

The F7 are (FUSE 3A 125V)

The NTC4 are (NTC 10 OHM 3.0A)

The REC3 are (GBU4M 4A 1000V UFST)

The D83 are (RHRP8120 8A 1200V)

The Q20 are (IRFBG30 3.1A 1000V)

The Q19 are (2SC5353BL 3A 750V)

The U23 are (IC PWM UC3845BNG DIP-8)

The TX12 are (TX 26:4:42:27 FER EC28)

The C176 are (33uF 450V)

维修手册

专案名称: Axpert VM III-5000/VM III-3000

专案编号: S1711171

修订版次:

00

PAGE

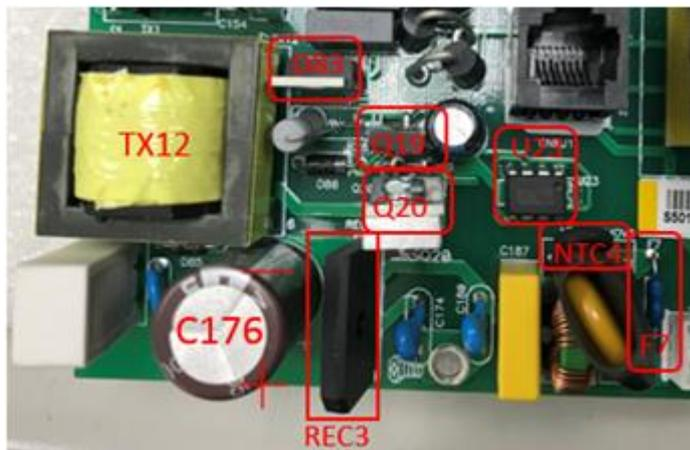

Parts	Attribute	Reference values	Failure status
F7	Resistor	0.1 ohm	Open or explosion
NTC4	Resistor	11.4 ohm	
D83	Diode	+ to -: 0.458V - to +:OL	Short or explosion
Q20	Resistor	GS: 45.27k SD: 4.711K	Short or explosion
	Diode	SD: 0.536V SG: OL	Short or other values
Q19	Resistor	BC: 361.9k BE: 411.6k	Short or explosion
	Diode	BC: 0.598V BE: 0.611V	
U23	Diode	PIN5 TO PIN7: 0.492V PIN5 TO PIN6: 0.639V	Short or other values
	Resistor	PIN1 TO PIN3: ohm	Short or other values
C176	Capacitance	33uF/450V	

2.7 Check the bus soft start circuit (TX1: Especially for 09 fault)

The D82 are (RHRP8120 8A 1200V UFST)

The R238 are (RES 0.62 J)

The MOSFET Q17 are (IRFBG30 3.1A 1000V TO-220)

The D67 and D73 are (MUR4100ERLG 4A 1000V UFST)

The U18 are (IC PWM UC3845BNG DIP-8)

The TX1 are (TX 55:200:44 FER EEL16)

The R260 are (22R 1206)

The R235 are (1KR 1206)

The R258 are (1.2KR 1206)

The C176 are (33uF 450V)

Note: If R260 is damaged, please replace U18 together.

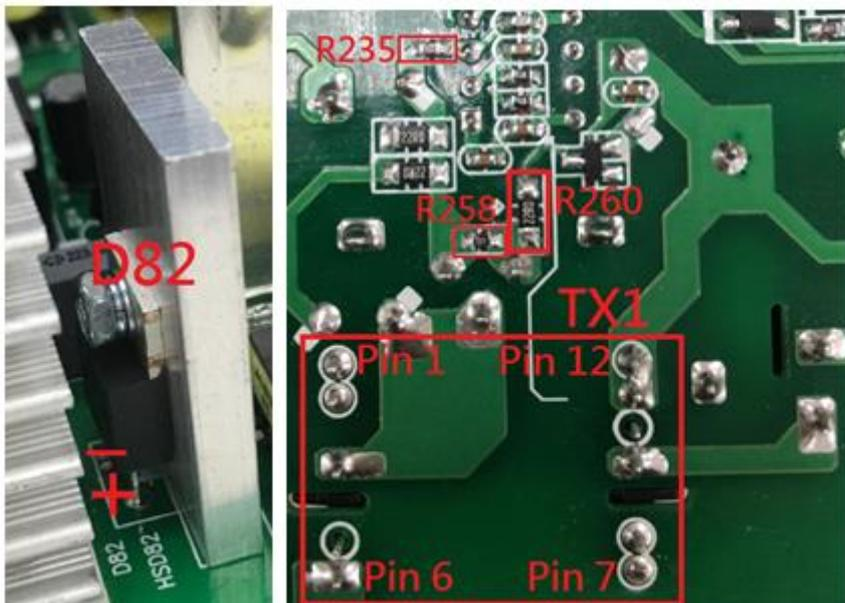
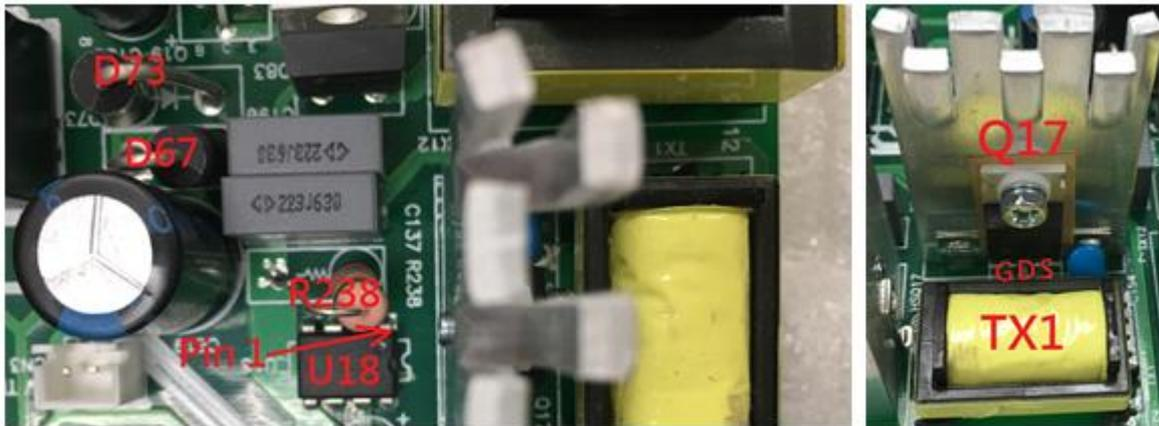

Parts	Attribute	Reference values	Failure status
D82	Resistor	+ to -: 237k - to +: OL	Short or explosion
	Diode	+ to -: 0.458V - to +: OL	



专案名称: Axpert VM III-5000/VM III-3000

专案编号: S1711171

修订版次:

00

PAGE

Parts	Attribute	Reference values	Failure status
Q10, Q11	Resistor	GE: 18.29k GC: 206.1k CE: 358.7k	Short or explosion
	Diode	EC: 0.389V CE: OL	
D52	Diode	+ to -: 0.39V - to +: OL	

### Drivers

The U11 are (FOD3150ASD SO-8)

The D27 and D28 are (1N4148W 0.15A 75V SMD)

The R60 and R223 are (10R 1206)

The R225 and R229 are (39R 1206)

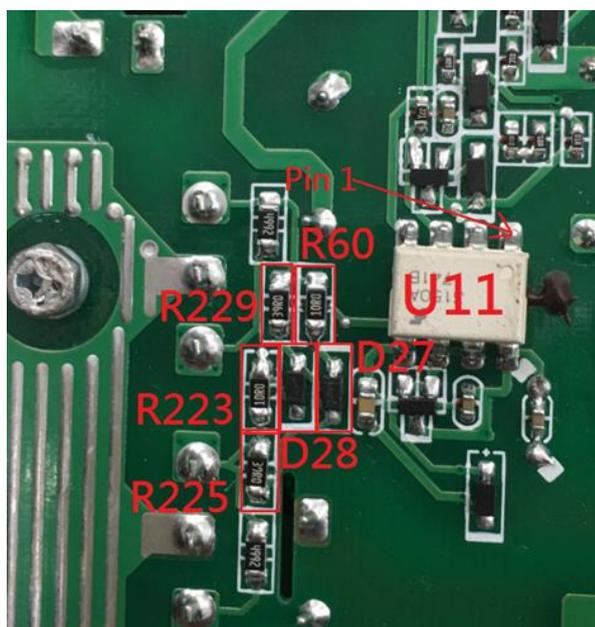

Parts	Attribute	Reference values	Failure status
U11	Resistor	PIN8 TO PIN5: 350.7k PIN7 TO PIN5: 388k	Short or other values
D27/ D28	Diode	+ to -: 0.6V - to +: OL	Short or explosion

专案名称: Axpert VM III-5000/VM III-3000

专案编号: S1711171

修订版次:

00

PAGE

R60/ R223	Resistor	10 ohm	Open or other values
R225/ R229	Resistor	39 ohm	Open or other values

**Note:** When test the diode; please remove the R60/ R223 from the board, or the test result is not right.

### 3. Disassembling guide

Remove 8 screws on top cover and rear panel.



Remove LED cable and LCD cable, and take out the Remote cover.



Remove the plastic screws of wind pipeline. Be careful not to damage them. You can use an oblique mouth clamp to help you to remove the clip.

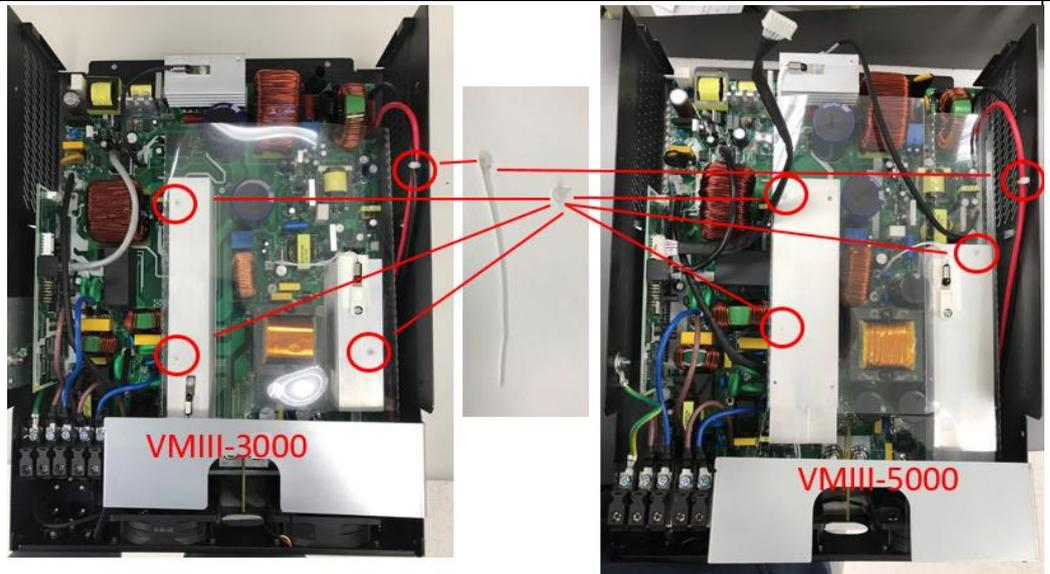

**Note:**

**Please make sure that put the plastic sheet back and fix well. Otherwise it will affect the heat dissipation.**

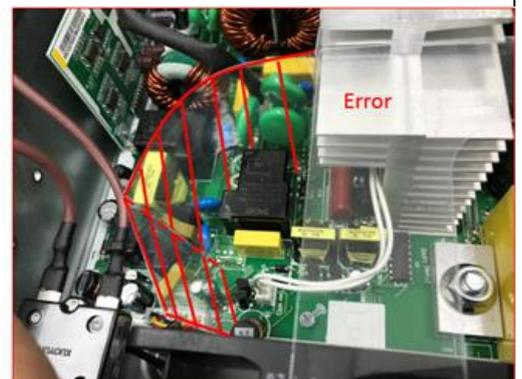
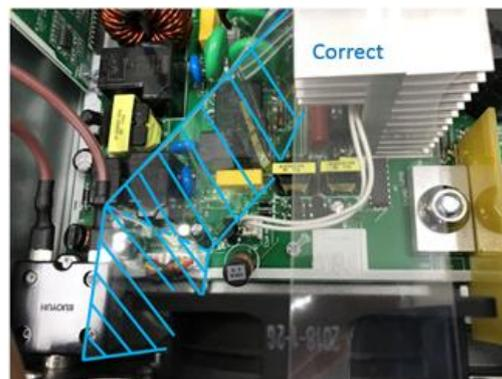

Remove I/P and O/P cables.

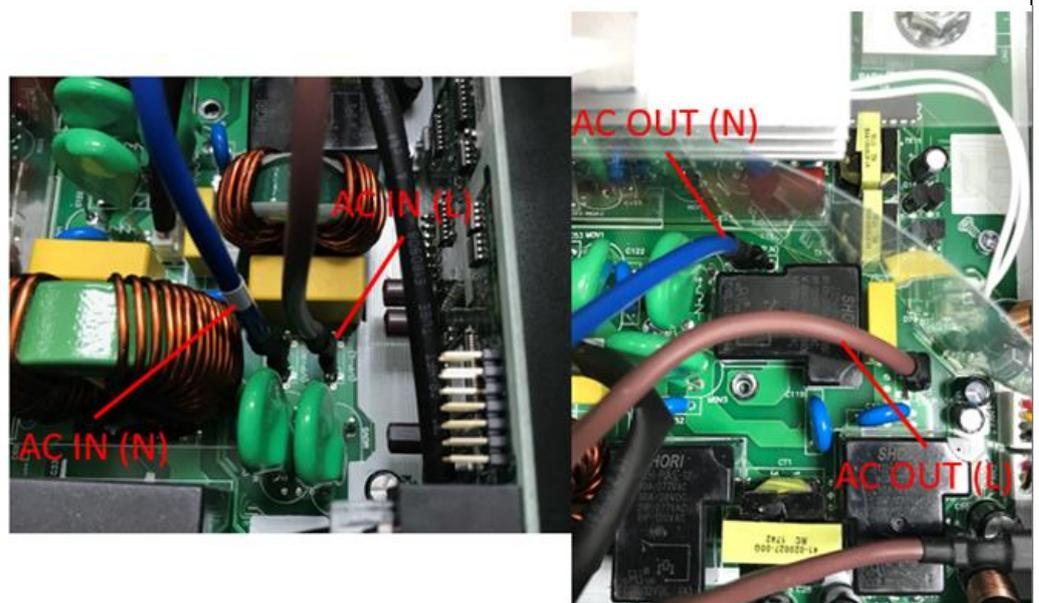

Remove the fan cables.

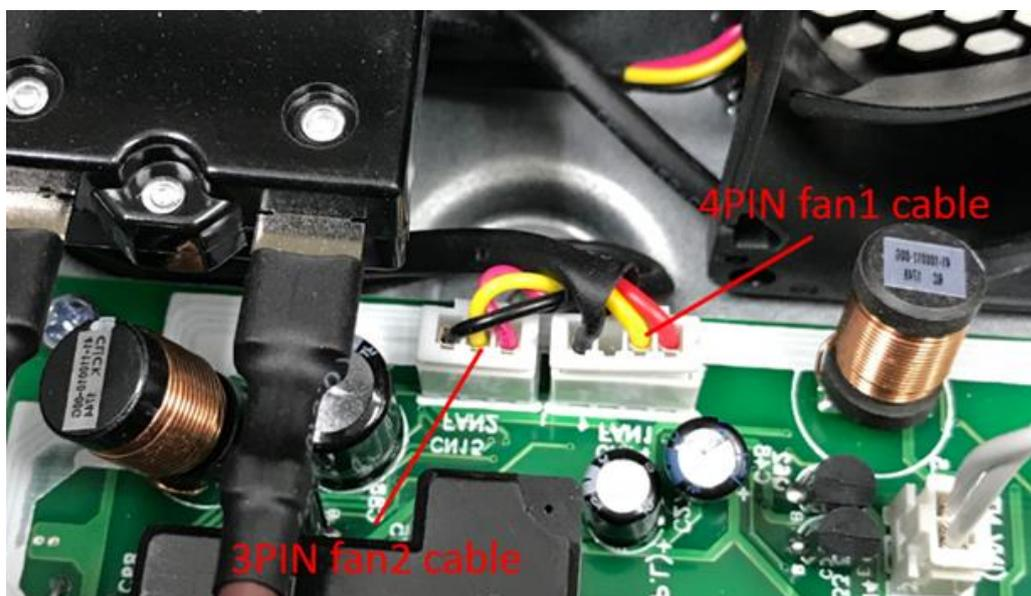

Remove PV IN cable

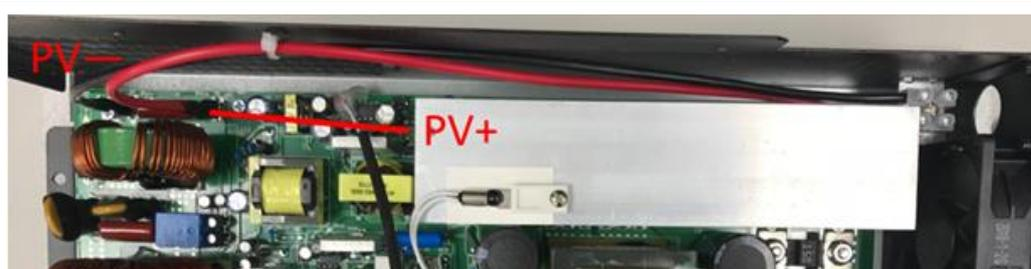

MPPT NTC and Converter NTC and INV NTC



Remove 13 screws on main board and take out the main board

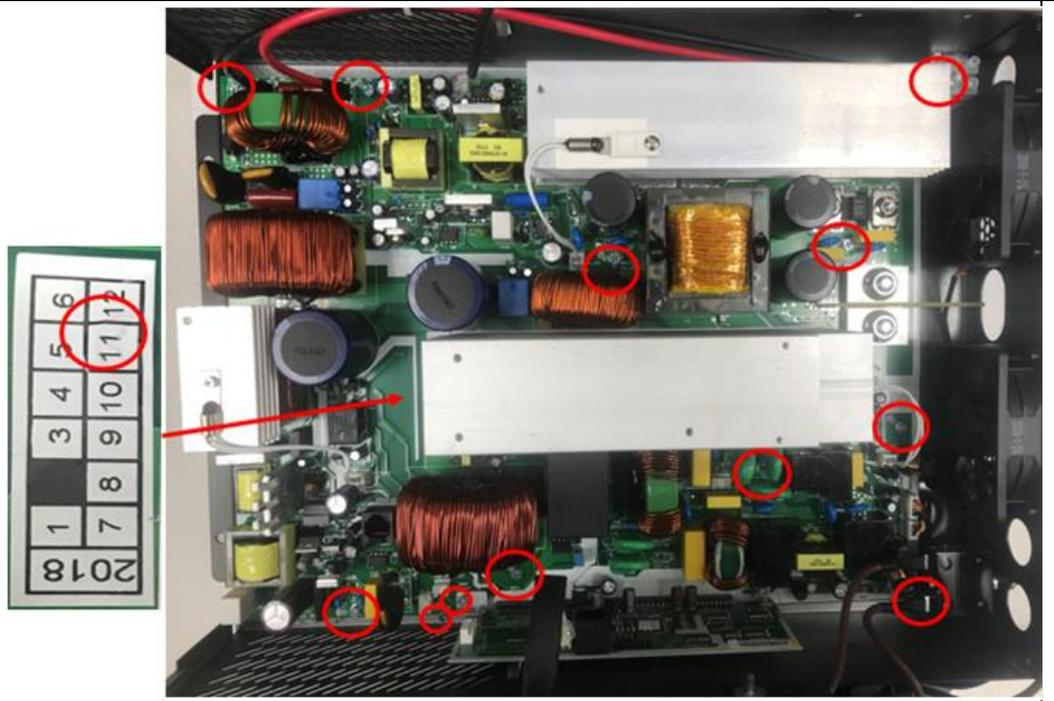

1.1 Total wiring diagram:

Note: Wrong connection of wires may cause inverter damage!

Please connect wires with care!

